

SM30 Series EZ-BEAM Opposed Mode Sensor Pairs

Leakproof 30-mm dc barrel sensors for demanding industrial applications



- Economical opposed mode sensor pairs in leakproof 30-mm threaded VALOX® barrels; quad-ring sealed acrylic lenses
- Ideal for high-humidity and high-pressure washdown applications such as laundries, car washes, and food processing
- Sensing range of 60 meters (200 feet)
- Totally self-contained; 10 to 30 volt dc operation
- Complementary outputs: one normally open, one normally closed; choice of NPN (sinking) or PNP (sourcing) configuration, 150 mA max. (continuous, each output)
- One output may be used as a marginal signal alarm



These are economical opposed mode sensor pairs in leakproof (NEMA 6P, IEC IP67 rated) 30-mm threaded barrel VALOX® housings. Their size, shape, leakproof construction, mounting options, and price make them ideally suited for use in applications which undergo high-pressure washdown, such as car washes and food processing. Emitters and receivers must each be ordered separately (see below).

These sensors operate from 10-30V dc. Emitters draw 25 milliamps; receivers draw 20 milliamps maximum continuous, exclusive of load current. Receiver outputs are complementary: one normally open (N.O.) and one normally closed (N.C.), each capable of switching up to 150 milliamps (continuous). Receivers are available with either NPN sinking or PNP sourcing outputs. Models with NPN (current sinking) outputs are directly compatible as input devices to Banner logic modules, including all of the non-amplified MAXI-AMP™ and MICRO-AMP® modules.

The normally closed (N.C.) receiver output may be configured as a normally open (N.O.) alarm output (US patent no. 5087838) by reversing the receiver's hookup to the power supply. The alarm output conducts when the receiver's excess gain in the light condition drops below 1.5x. An easily-visible, internally-mounted red

indicator LED lights when the receiver "sees" the emitter's modulated light source, and flashes to indicate marginal excess gain (1-1.5x) in the light condition. The flashing LED corresponds to the "on" state of the alarm output.

SM30 Series EZ-BEAM opposed mode sensors are available with a 6-1/2 foot long attached PVC-covered cable or a 4-pin euro-type QD fitting. Mating QD cable must be purchased separately (see Specifications section).

Electronics are fully epoxy-encapsulated for maximum resistance to mechanical shock and vibration. Positive sealing at both ends of the sensor with no exposed epoxy interfaces eliminates all leakage paths (including capillary leakage). The acrylic lens is quad-ring sealed.

Specifications and model listings:

Sensing range: 60 meters (200 feet).

Sensing beam: infrared, 880 nanometers.

Supply voltage: 10 to 30V dc at 25 mA for emitters (reverse polarity protected); 20 mA max. for receivers, exclusive of load. 10% max. ripple.

Emitter model listing:

Use emitter SM306E (attached cable) or SM306EQ (euro-type QD fitting).

Receiver model listing and output configurations:

Solid-state dc complementary outputs:

SM30SN6R = NPN sinking, N.O. & N.C. (attached cable)

SM30SN6RQ = NPN sinking, N.O. & N.C. (euro-type QD fitting)

SM30SP6R = PNP sourcing, N.O. & N.C. (attached cable)

SM30SP6RQ = PNP sourcing, N.O. & N.C. (euro-type QD fitting)

Light operate: N.O. output conducts when the receiver sees the emitter's modulated light source.

Dark operate: N.C. output conducts when the receiver does *not* see the emitter's modulated light source. The N.C. (normally closed) output may be used as an alarm output, depending upon hookup to the power supply.

Receiver output rating: 150 mA maximum (each) in standard hookup. Short-circuit protected.

Off-state leakage current <1 microamp at 30V dc.

On-state saturation voltage <1V at 10 mA dc; <1.5V at 150 mA dc.

When wired for alarm output, the total load may not exceed 150 mA.

Response time: 3 milliseconds "on"; 1.5 milliseconds "off". No false pulse on power-up (false pulse protection circuit causes a 100 millisecond delay on power-up). **Repeatability** 375 microseconds. Response time and repeatability are independent of signal strength.

Indicators: Receivers have red LED which lights whenever the receiver "sees" the emitter's modulated light source, and flashes to indicate marginal excess gain (1-1.5x) in the light condition. Emitters have red LED which lights to indicate DC POWER ON. Indicators are internally-mounted and are visible both through the sensor's lens from the front and through a sealed side viewing port near the lens.

Construction: M30x1.5 threaded VALOX® tubular housing with positive sealing at both ends. Completely sealed; epoxy-encapsulated circuitry. Quad-ring sealed acrylic lens. Exceeds NEMA 6P and IEC IP67 ratings. Two VALOX® jam nuts provided.

Cabling: 6-1/2 foot long (2 meter) attached PVC-covered 2-wire cable (emitters) and 4-wire cable (receivers), or 4-pin QD cable as follows:

MQDC-415 cable for models with Q model suffix; 12 feet long, straight euro-type QD connector

MQDC-415RA cable for models with Q model suffix; 12 feet long, right-angled euro-type QD connector

Vibration and mechanical shock: meets Mil. Std. 202F requirements. Method 201A (Vibration: frequency 10 to 60 Hz, max., double amplitude 0.06-inch, maximum acceleration 10G). Method 213B conditions H & I (Shock: 75G with unit operating; 100G for non-operation).

Operating temperature range: -40° to +70°C (-40° to 158°F).

Maximum relative humidity 90% at 50°C (non-condensing).

Lexan® and VALOX® are registered trademarks of General Electric Co.

Hookup, SM30 Series dc opposed mode receivers

NPN (sinking) models SM30SN6R and SM30SN6RQ*

Standard hookup

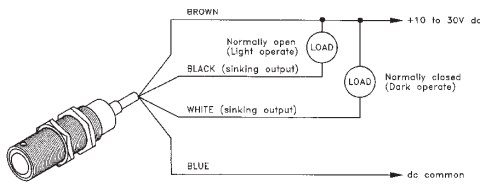

* QD model, requires MQDC-415 or MQDC-415RA mating cable

Hookup for alarm output

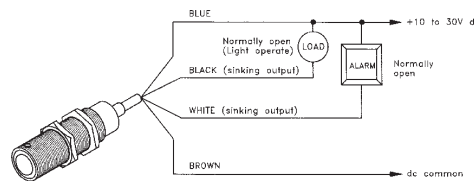

PNP (sourcing) models SM30SP6R and SM30SP6RQ*

Standard hookup

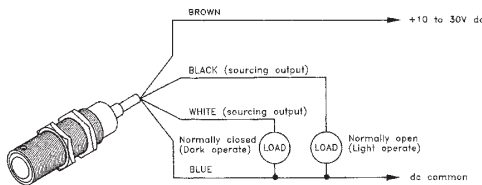

Hookup for alarm output

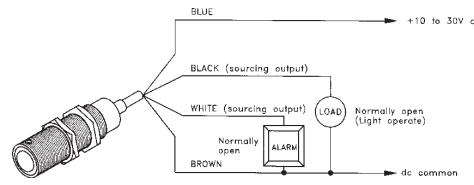

Excess Gain Curve

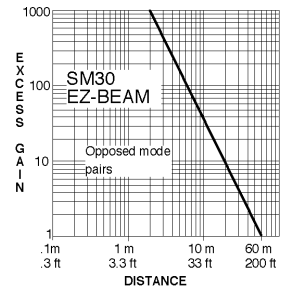

Beam Pattern

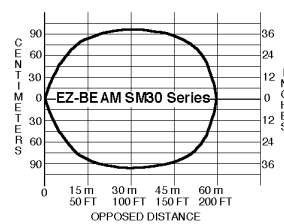

Hookup, SM306E & SM306EQ* dc emitters

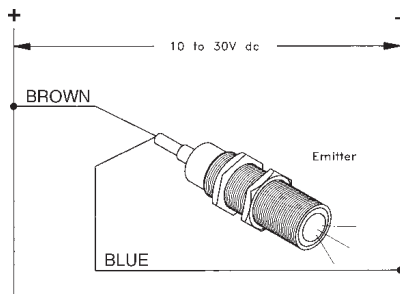

* QD model requires MQDC-415 or MQDC-415RA mating cable

Mounting Options for EZ-BEAM SM30 Series

The **model SMB30A two axis mounting bracket** has a curved mounting slot for versatility and orientation. The SM30 Series sensor mounts to the bracket using a jam nut (supplied with the sensor). The curved mounting slot has clearance for 1/4-inch screws. Bracket material is 11-gauge stainless steel.

The **model SMB30S swivel-mount bracket** offers the ultimate in flexibility and convenience. This bracket mounts by its base. The SM30 threads into the "ball" of the bracket, which locks snugly in position when two clamping bolts are tightened. Bracket material is black VALOX®. Hardware is stainless steel, and mounting bolts are included.

The **model SMB30C split clamp** mounts to a flat surface and grips the SM30 sensor by its threaded barrel. This bracket is similar to the SMB30S, but without the adjustable ball.

SM30 Series sensors may also be mounted in a 30-mm clearance hole, using the supplied jam nuts.

Dimensions, EZ-BEAM SM30 Series sensors

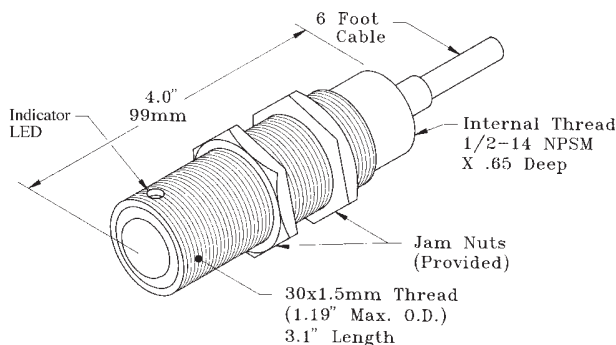

Quick Disconnect fitting adds .35" (9 mm) in overall length to QD models.

QD models require model MQDC-415 or MQDC-415RA cable (cable must be ordered separately from sensor).



WARNING These photoelectric presence sensors do NOT include the self-checking redundant circuitry necessary to allow their use in personnel safety applications. A sensor failure or malfunction can result in either an energized or a de-energized sensor output condition.

Never use these products as sensing devices for personnel protection. Their use as safety devices may create an unsafe condition which could lead to serious injury or death.

Only MACHINE-GUARD and PERIMETER-GUARD Systems, and other systems so designated, are designed to meet OSHA and ANSI machine safety standards for point-of-operation guarding devices. No other Banner sensors or controls are designed to meet these standards, and they must NOT be used as sensing devices for personnel protection.

WARRANTY: Banner Engineering Corporation warrants its products to be free from defects for one year. Banner Engineering Corporation will repair or replace, free of charge, any product of its manufacture found to be defective at the time it is returned to the factory during the warranty period. This warranty does not cover damage or liability for the improper application of Banner products. This warranty is in lieu of any other warranty either expressed or implied.